



# Not just aluminium, Novelis Aluminium.

Novelis is the world's largest producer of rolled aluminum and the global leader in beverage can recycling. We are a growth-oriented company, drawing upon our industry-leading technology and expertise to develop and deliver an expanding portfolio of premium rolled aluminum products.

Novelis is an important part of the worldwide Aditya Birla Group of companies. By partnering with our customers to bring innovative products to market, by being a leader in recycling, and by operating with a mindset of sustainability, Novelis makes the world lighter, brighter and better.

Novelis Deutschland GmbH  
Hannoversche Strasse 1  
37075 Göttingen  
Tel +49 551 304-0  
Fax +49 551 304-474  
sales.goettingen@novelis.com  
[www.novelis.com](http://www.novelis.com)

Certified to DIN EN ISO 9001, DIN EN ISO 14001,  
DIN EN ISO 50001, OHSAS 18001.

All the information and technical data given reflect the situation and our experience on the date when this brochure went to print. We reserve the right to make changes.

# Novelis

Products

# Novelis solid aluminium for facades with fantasy



# Novelis

# Facades with fantasy

---

Whether for renovation or for new projects, it is usually economic considerations that prompt the use of pre-painted aluminium for ventilated facades. The material provides a variety of design possibilities, longevity and low operating costs during the use of the building. As well as weatherproofing, the material meets the demanding physical property requirements.



## Novelis pre-painted aluminium for facades 2.0 and 3.0 mm thick

---

Novelis has developed solid pre-painted aluminium products in different thickness especially for facade cladding:

**ff<sup>2</sup>** pre-painted aluminium for facades,  
2.0 mm thick

**ff<sup>3</sup>** pre-painted aluminium for facades,  
3.0 mm thick

### Ideal for facades: ff<sup>2</sup>® and ff<sup>3</sup>®:

- Non-combustible - A1 certified according to DIN EN 13501
- Especially weather-resistant PVdF coating
- Extremely flat, low stress
- High strength, wide span-width, economical
- Very low maintenance requirements



Middelbart Bank, Denmark



Middelbart Bank, Denmark

# Alloy for wider span-width flat - stress-free - high strength

The 2.0 mm thick aluminium panel ff2<sup>®</sup>, with its AlMg3 alloy in temper H42 developed especially for facades, similar span and fixing widths like established AlMg1 alloys with a thickness of 3.0 mm. This means that the weight of material is reduced by a third and that the same span width can be obtained with this lower material thickness. The material is ideal for minimizing material handling, installation and transportation costs.

**AlMg3, thickness 2.0 mm = 5,4 kg/m<sup>2</sup>**

**AlMg1, thickness 3.0 mm = 8,1 kg/m<sup>2</sup>**

Even in large surface applications under high stress loads, e.g. in high-rise buildings with extreme wind loads, ff2<sup>®</sup> is the perfect solution.

The material has a low weight per surface area, at 5.4 kg/m<sup>2</sup>.

Nevertheless, effortlessly the solid aluminium material stands up to high wind loads. Building movements and temperature changes are compensated without any problems.

As the alloy is seawater-resistant, ff2<sup>®</sup> and ff3<sup>®</sup> can be used in extreme climate zones (Germanischer Lloyd test certificate).

## Structural design comparison ff2<sup>®</sup>, ff3<sup>®</sup>, AlMg1

Load [kN/m <sup>2</sup> ]	Max. span width [m]		
	ff2 <sup>®</sup> 2 mm	AlMg1 H14 3 mm	ff3 <sup>®</sup> 3 mm
0,5	1,00	1,02	1,50
1,0	0,71	0,72	1,06
1,5	0,58	0,59	0,87
2,0	0,50	0,51	0,75
2,5	0,45	0,46	0,67
3,0	0,41	0,42	0,61
3,5	0,38	0,39	0,57
4,0	0,35	0,36	0,53

according to DIN EN 4113, DIN EN 1396

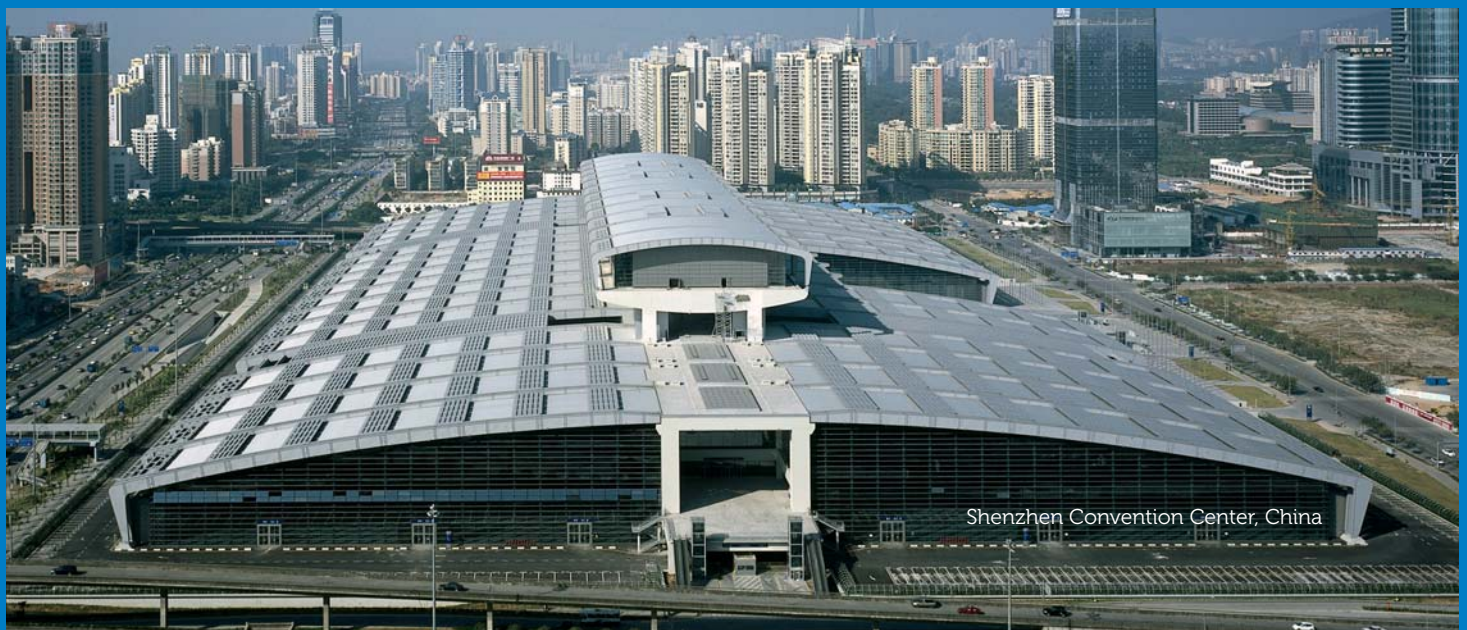
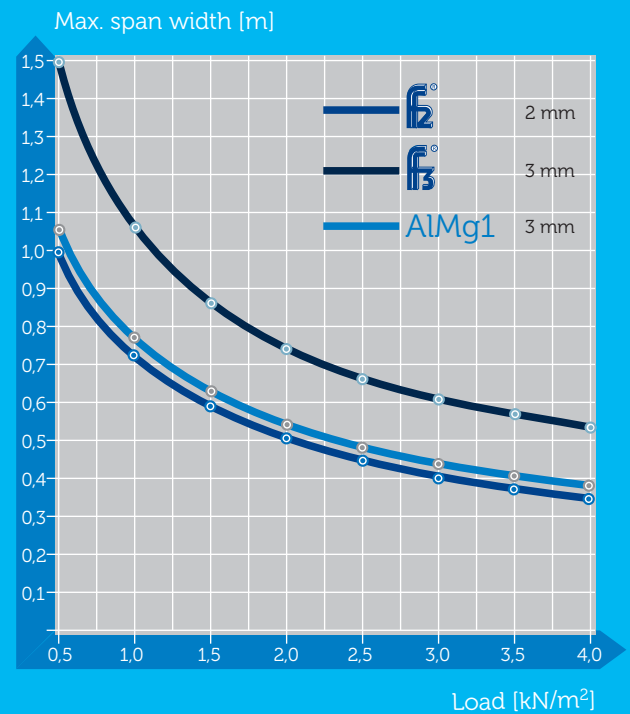

# Surface quality for longevity and economics

The decisive factors are colour consistency and surface durability.

## UV-resistant coating

This is why we coat ff2<sup>®</sup> and ff3<sup>®</sup> pre-painted aluminium in a continuous coil coating process.

Solid and metallic paints are applied in two or four coats and then permanently stove-enamelled. This process ensures a durable, brilliant colour effect.

For high-grade outdoor architectural applications, Novelis uses only PVdF (polyvinylidene fluoride) paints of the highest quality (80/20).

As a general principle, the higher the PVdF share in the paint, the better the weather resistance. PVdF paints contain mainly inorganic pigments and are extremely well-suited for outdoor applications. They feature high resistance to ultraviolet radiation and environmental effects, also in extreme climate zones.

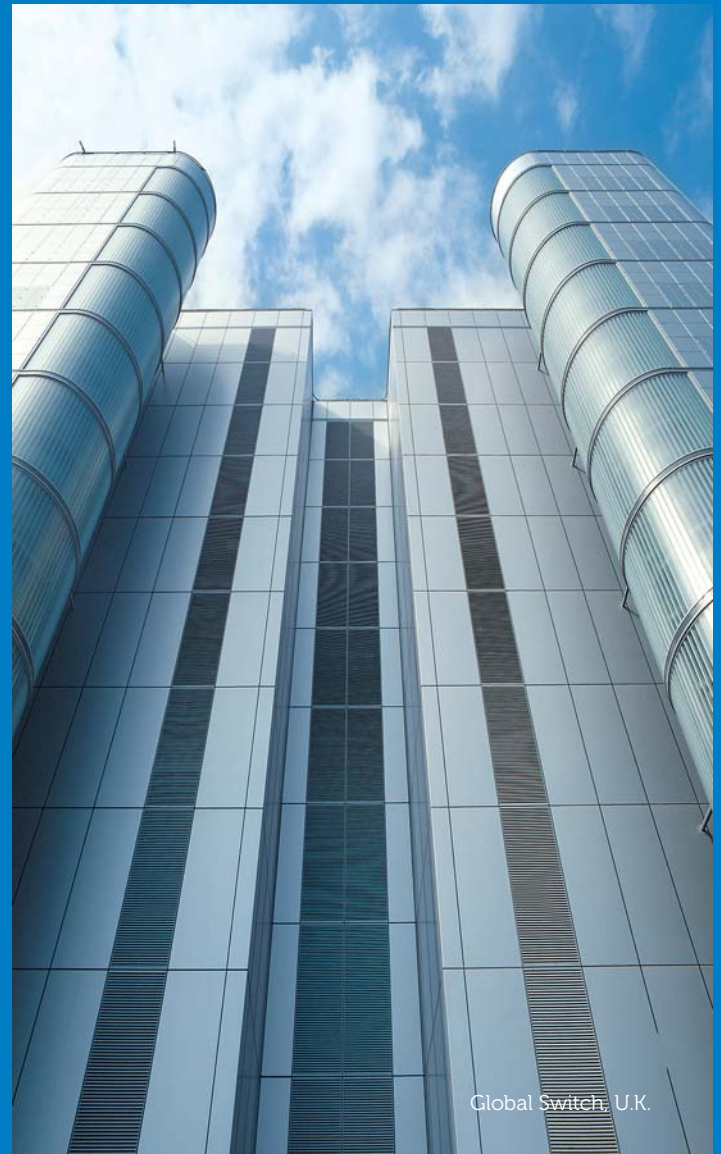

Global Switch, U.K.



Fraunhofer Institut, Germany

# Colours for modern architecture

Metallic shimmer or high-gloss to matt: various solid and metallic colours, copper tones, terracotta and stainless steel effects - we are continuously developing new surfaces for individuality in architecture. Special colours are available on request.



Beloura, Portugal



Children Hospital, Russia



DESY Petra III, Germany



Subway Station, Russia

## Colour retention

(Florida 45° South)

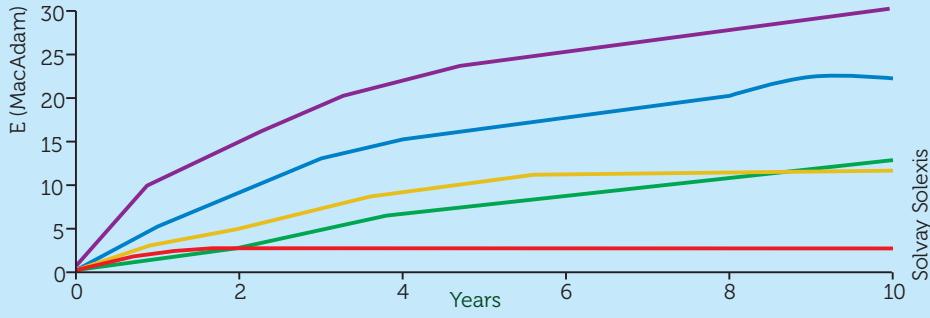

## Durable Novelis PVdF paint quality

During the outdoor weathering tests of different paint qualities, the following parameters are investigated:

1. Colour retention
2. Gloss retention
3. Chalking behaviour

Internal Novelis test procedures are far more stringent than the normal ECCA test standards.

## Gloss retention

(Florida 45° South)

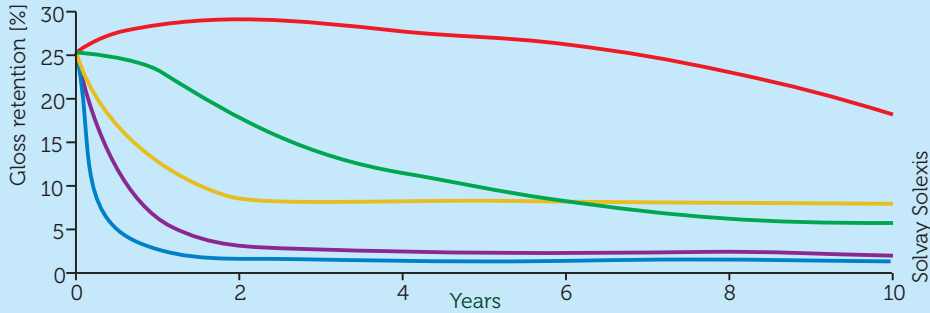

## Chalking behaviour

(Florida 45° South)

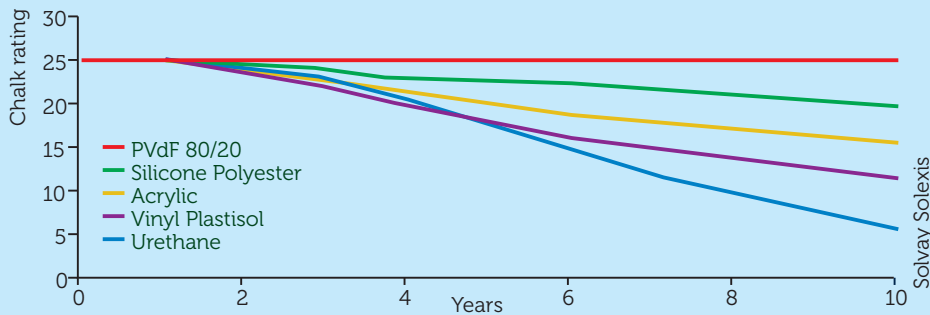

Museum of Modern Art,  
South Korea





# Easy processing

Whether you prefer panels, cassettes or flat sheets and whatever type of substructure you prefer, ff2<sup>®</sup> and ff3<sup>®</sup> are equally well-suited for ventilated and non-ventilated cladding structures.

The easy forming properties of ff2<sup>®</sup> make the material ideal for concave or convex shapes, corners, closures, column casing and other details. Coil-coated aluminium can be processed after coating.

When making cassettes and panels the minimum bending radius and the processing temperature should be taken into consideration (see technical data).

ff2<sup>®</sup> and ff3<sup>®</sup> can be easily drilled, stamped, punched, bent, trimmed and stud welded without any damage to the material or painted surface.

For protection from damage and dirt during transportation, processing and installation, the material is supplied with an ultraviolet-resistant protective film on the painted side.

This foil remains on the sheet during installation and is simply pulled off after the completion of installation.

The film is recyclable and has no detrimental effect with rain water.



## Cleaning

PVdF coatings provide an easy to clean surface. In contrast to polyester-coated aluminium cladding, ff2® and ff3® facades are dirt-repellent and require very little maintenance.

Minor dirt can be cleaned by using environmentally friendly warm water and neutral detergents. Graffiti can normally be removed using special cleaning agents.

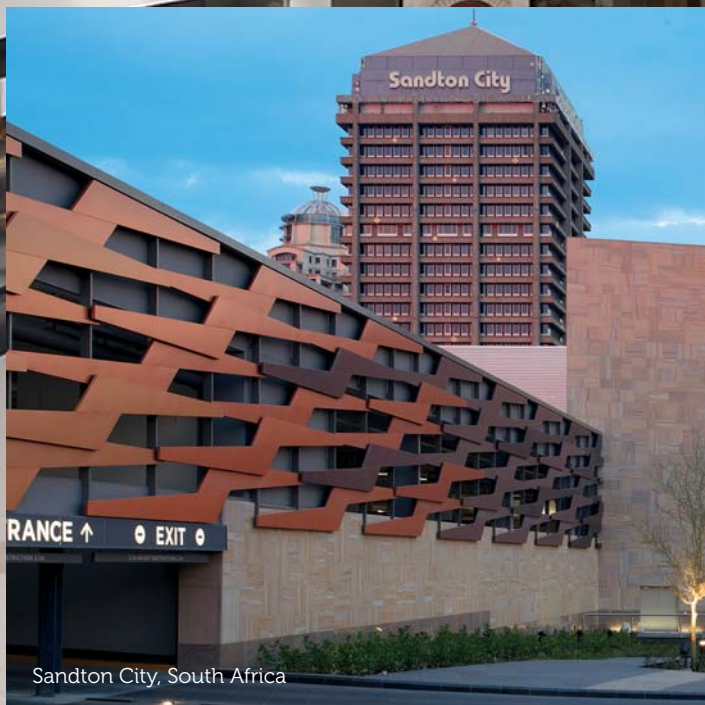

Sandton City, South Africa



# Installation techniques

As well as conventional fastening techniques for facade cladding, bonding and stud welding (ff3®) are possible installation methods for invisible fastening.

Flat sheet

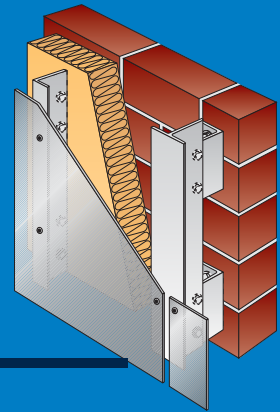

Panel

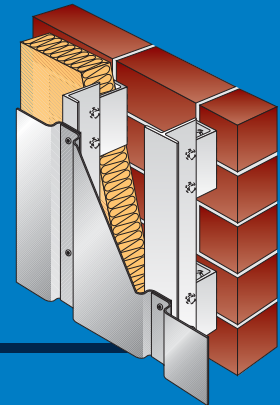

Cassette with hook-in-system

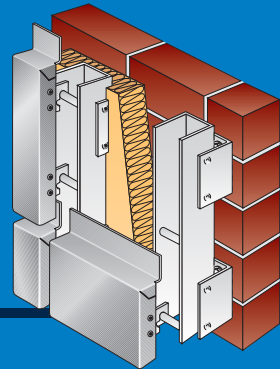

Cassette with non-visible-fixing

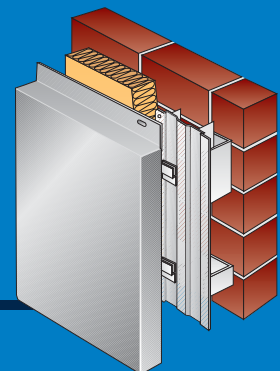

Flat sheet stud welded

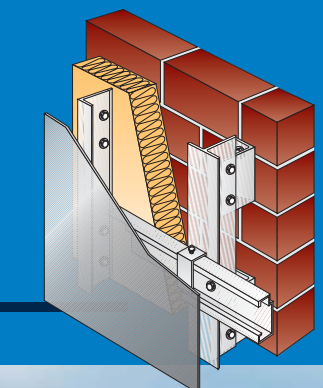

## Adhesive bonding

The lacquer on the reverse side of Novelis facade material is specially designed for bonding. For this reason ff2® and ff3® sheets can be adhesive-bonded to the sub-structure without any visible fixings. Reinforcements can easily be bonded into the cassettes.



"The Wave", Netherlands

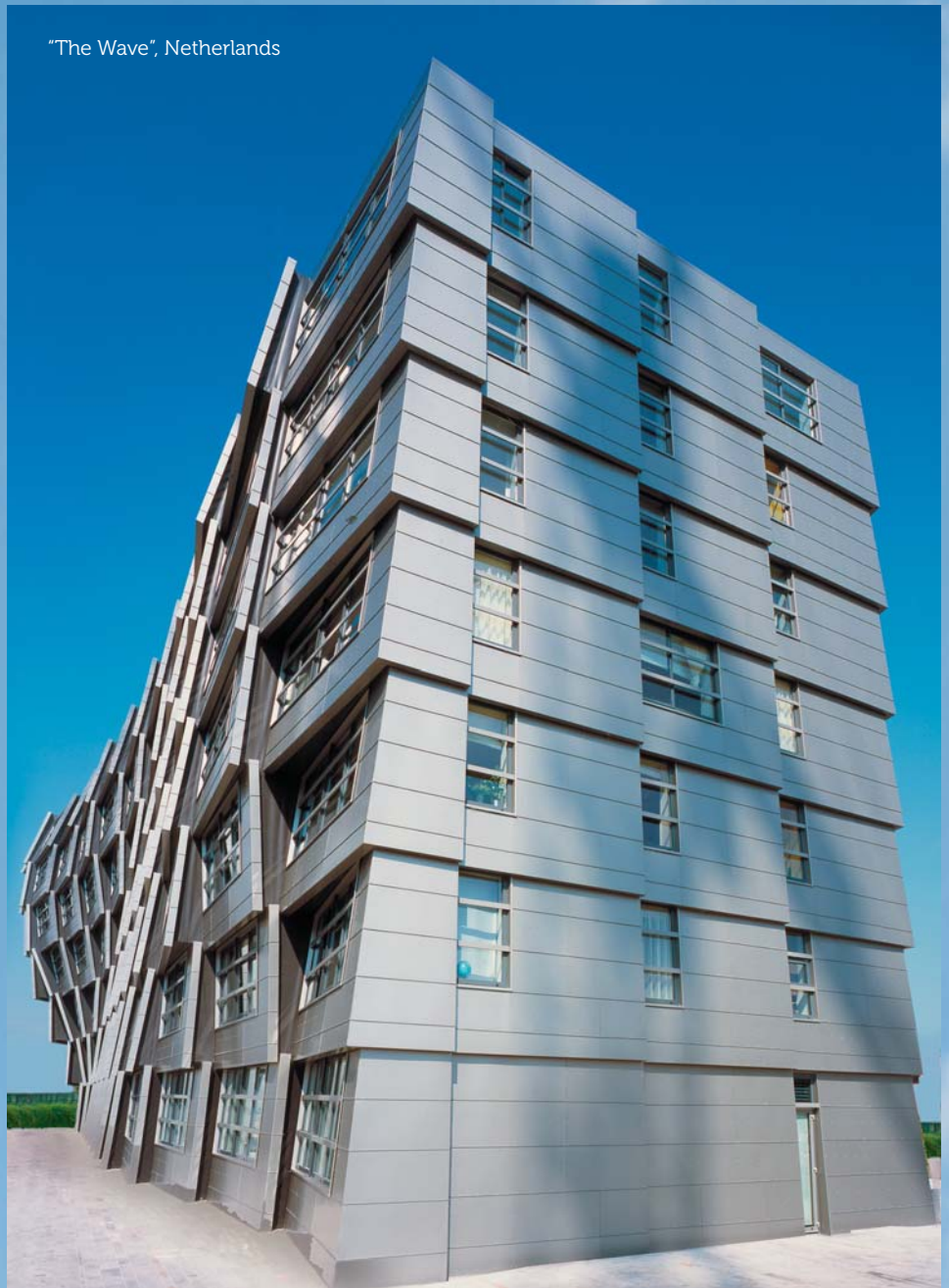

## Stud welding for ff3®

For concealed installation of the ff3® panels to the substructure, stud bolts are welded on the back of the panel. For this purpose, the surfaces of the components, bolts and panels, are melted for a short time (less than one second).

The alloy used for ff3® features excellent welding properties and is ideally well-suited for stud welding on the reverse without any impact on the decorative front side.

Quality assurance for stud welding joints is described in DIN EN ISO 14555.

# Facade installation

---

The most important requirement is a tension-free installation with fixed and sliding points.



Middelfart Bank, Denmark

The substructure should preferably be made from aluminium instead of wood or steel so that it has the same thermal expansion behaviour as the cladding material itself.

Fixed points bear the weight of the material, whereas sliding points accommodate wind loads. This type of installation ensures that thermal expansion can take place as necessary.

Another important factor is the difference between the installation temperature and the highest or lowest temperature expected on the installed facade.





## Fire leaves us cold!

Novelis pre-painted aluminium has been certified in accordance with the latest DIN EN 13501 non-combustibility standards.

Under international building regulations, only non-combustible materials may be used in buildings which are exceeding a certain height (approx. 20 m). For public facilities such as nurseries, schools, hospitals, hotels, airports, etc., this requirement applies irrespective of the height of the building.

Novelis ff2<sup>®</sup> and ff3<sup>®</sup> facade products received the highest rating of A1 in the combustibility tests.

ff2<sup>®</sup> and ff3<sup>®</sup> also obtained convincing results in the categories of smoke development and dripping fires.



**This means that ff2<sup>®</sup> and ff3<sup>®</sup> can be used on any building on any height without any restriction**



# Aluminium is environmentally friendly



Novelis pre-painted aluminium is produced by the environmentally friendly coil coating process. All paints and lubricants are processed in a closed material cycle.

When stoving the lacquer, 100% of the extracted solvents are combusted and fed back into the process. The pigments used in the paints are non-hazardous; indeed some of them are approved for use in food. ff2<sup>®</sup> and ff3<sup>®</sup> pre-painted solid aluminium are free from heavy metal erosion, are ground water neutral and can be recycled as

a raw material without any loss of quality. Nowadays 96% of the aluminium used in the European construction industry comes from recycling.

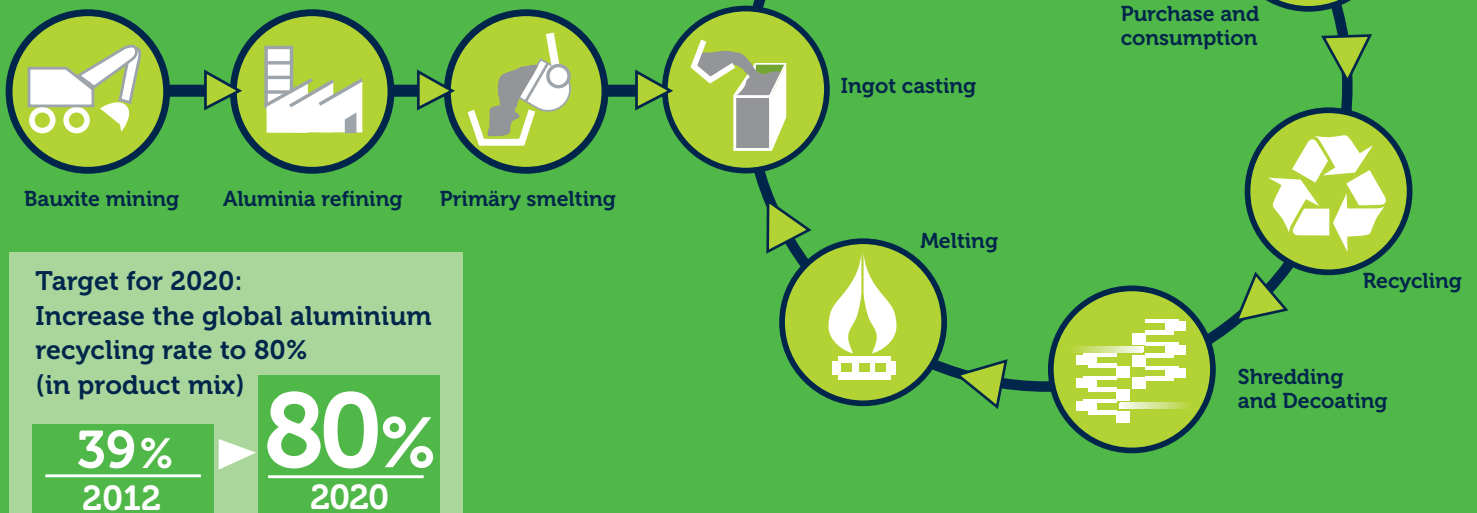

**Target for 2020:**  
Increase the global aluminium recycling rate to 80% (in product mix)

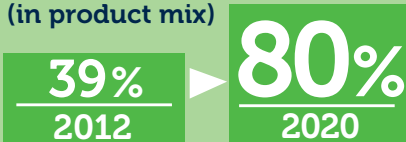

Thereby, the greenhouse gas emissions in the recycling process for aluminium products are reduced by 10 million tons per year.

Naturally, all process scrap at Novelis is segregated by alloy and fed back to the production process in its entirety.

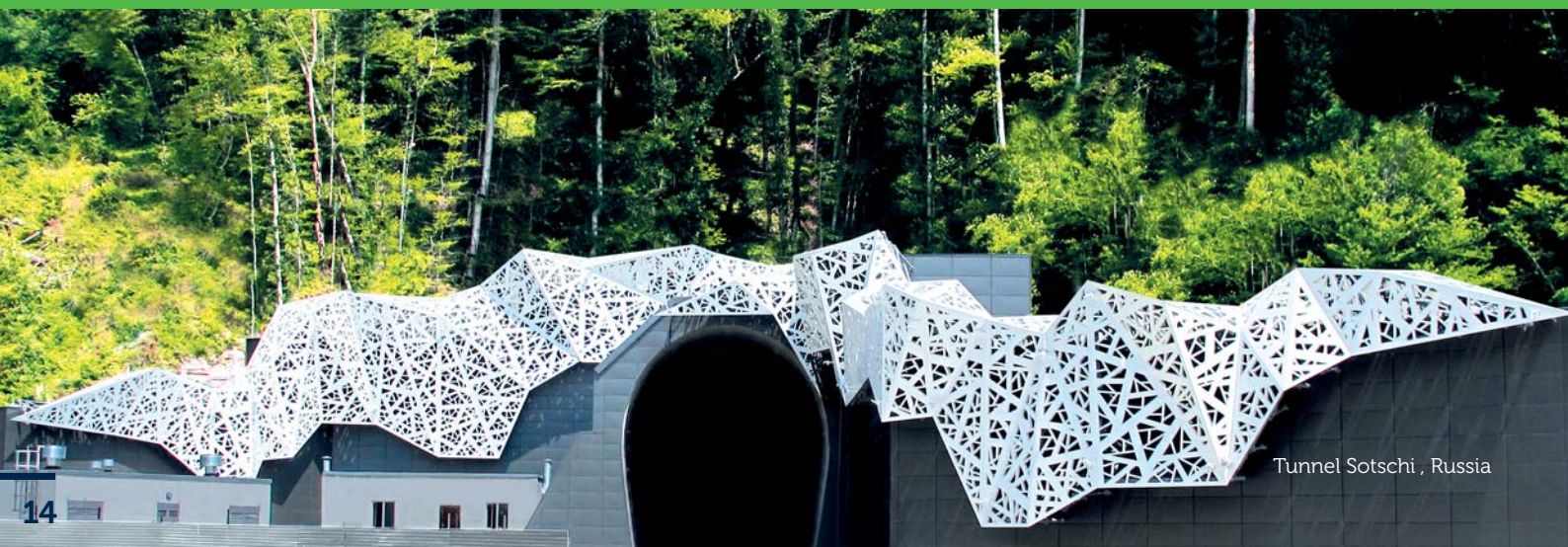

Tunnel Sotschi, Russia

# Technical data

## Alloy

Novelis WG-53S, EN AW-5754 (AlMg3) to EN 573-3, AA 5754 (international designation)

## Dimensions

Panels in standard dimensions

Thickness: ff2®: 2.0 mm  
ff3®: 3.0 mm

Width: 1500 mm, Length: 3000 mm  
Special dimensions on request

## Mechanical properties

Temper: H42 to EN 1396

Tensile strength: Rm 220-260 MPa

Elongation limit: Rp 0,2, 165-215 MPa

Elongation: A 50 > 9%

Permissible stress:  $\sigma_{perm} = 96$  MPa to DIN 4113

## Linear expansion

Co-efficient of linear expansion 0,024 mm/m/°K

## Elasticity

Modulus of elasticity -70.000 MPa

## Coating quality

Kynar 500 - Hylar 2000 in a mix 80/20

## Coating thickness

Front face approx. 24 µm, metallics 30-40 µm,  
reverse face approx. 3 µm

## Fire protection

ff2® and ff3® are non-combustible to EN 13501-A1

## Corrosion resisting

Novelis pre-painted aluminium ff2® complies the requirements according EN 1396:2007: C.6.1.1: category 2b und C.6.1.4, table C.1, category 2b DIN EN 1396; Annex C, Procedure C 6.5 (ASTM G85)

## Gloss

Approx. 20 units as per the Gardner measuring system, measuring angle 60°.

Metallic colours approx. 30-40 units, 30 units for ff3®

## Colours

Colours as per current Novelis colour chart as well as special colours developed on the basis of RAL, NCS etc. or on customer request.

Special and customised colours available from a min. quantity of 1500 m<sup>2</sup>.

## Installation

For a tension-free installation please consider also the following:

We recommend to use only panels from a single production batch. Especially all metallic colours must be installed in the same coating direction.

Precise instructions for the laying direction are printed on the reverse face of the facade panels.

## Quality control and certificates

Quality checks are based on Novelis' factory standard, EN, DIN, ASTM and BS standards and ECCA guidelines\*).

Quality assurance has been certified to ISO 9001.

Officially approved by DIBt Z56.426-592

